

SL-T3020IRC050-L236-C-S

Absolute Maximum Ratings at Ta=25

1. Storage and operating:

Electrical Optical Characteristics at Ta=25

	2					
Peak Wavelength	p	---	940	---	nm	I
		---	50	---	nm	I

Note:

2

Typical Electrical / Optical Characteristics Curves (25 Ambient Temperature Unless Otherwise Noted)

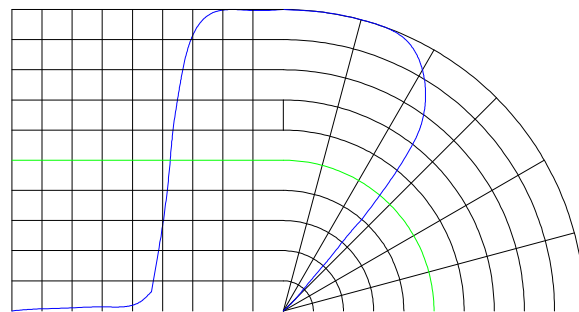
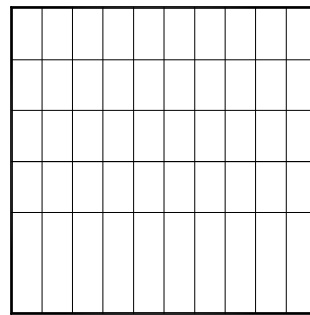
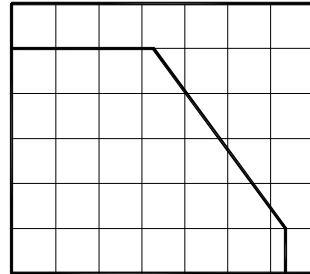
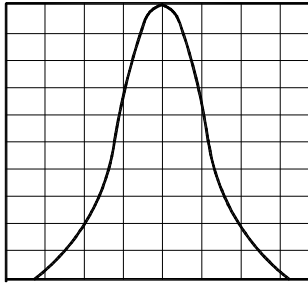

LIGHT

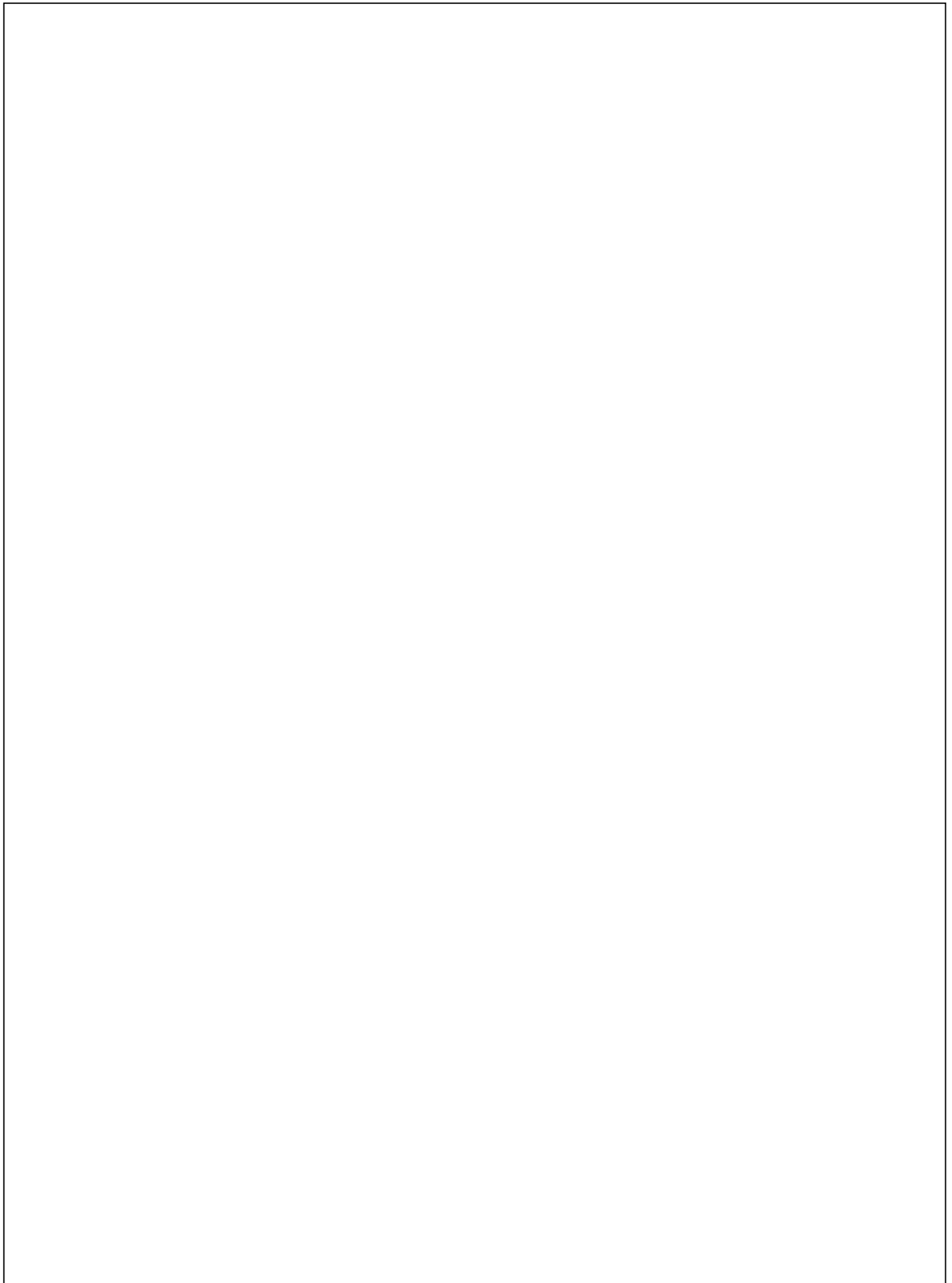

LIGHT
Light Electronics CO., LTD

MODEL NAME: _____

QUANTITY: _____

BIN: _____

PACKING DATE: _____

REMARKS: _____

LOT NO.: _____



LIGHT
Light Electronics CO., LTD

MODEL NAME: _____



QUANTITY: _____

BIN: _____

PACKING DATE: _____

CUSTOMER P/N: _____

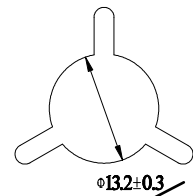
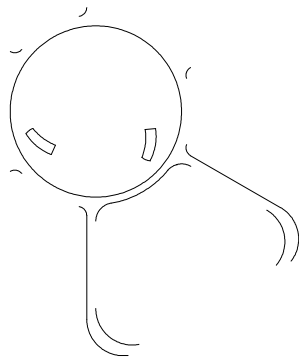
LOT NO.: _____



LIG

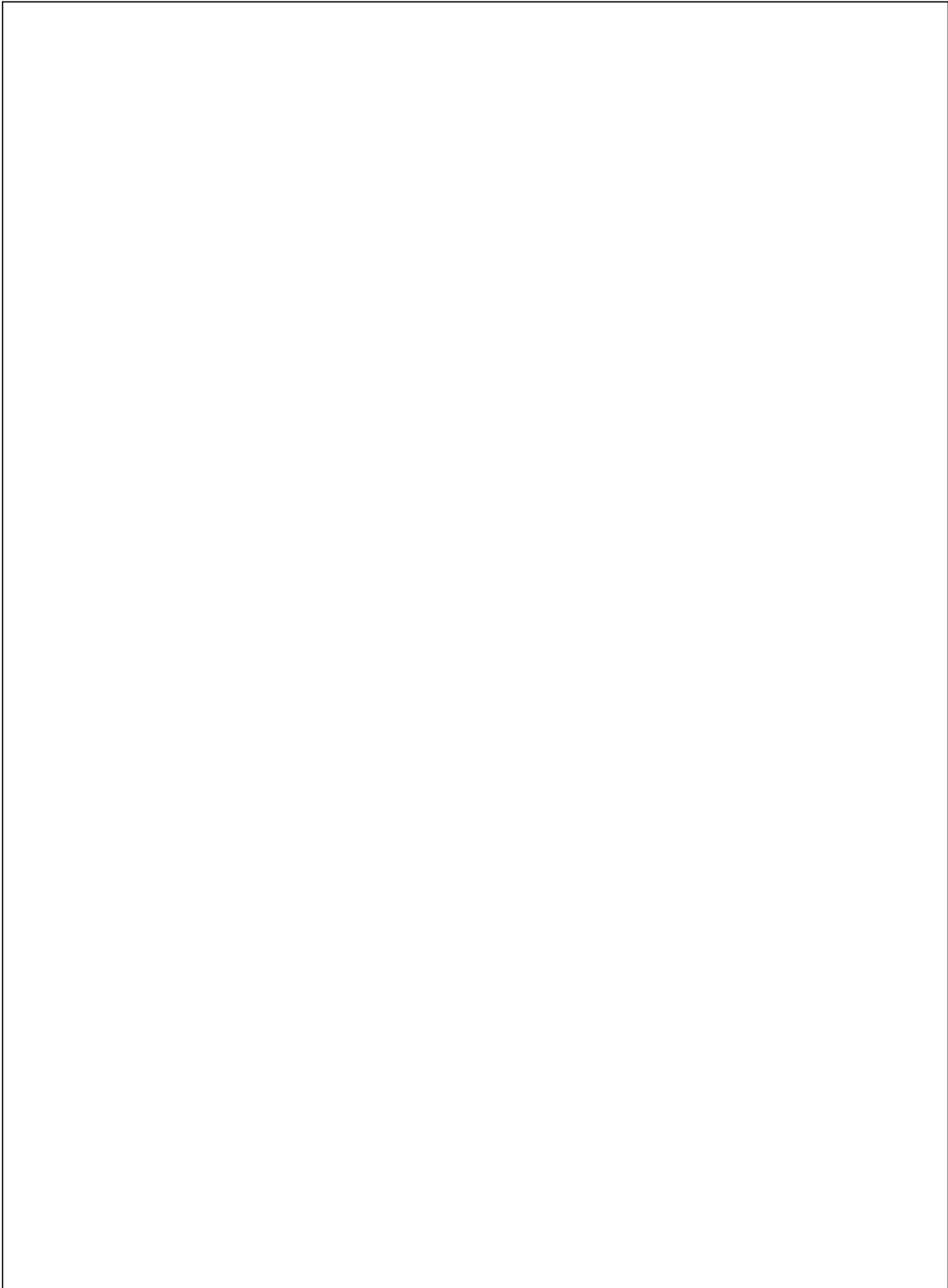

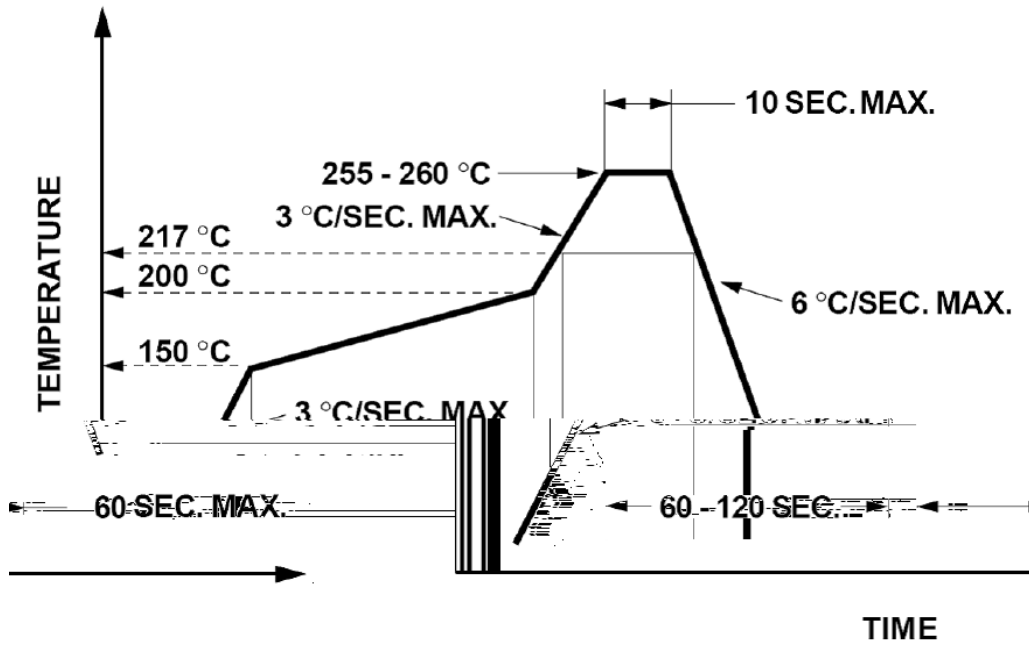

°C

