

Features

- Pb free product—RoHS compliant
- Low power consumption, High efficiency
- Reliable and rugged
- Long life – solid state reliability
- Viewing angle: 120°

Package Dimension

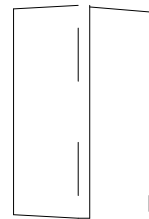
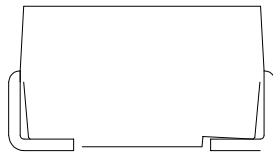

Part NO.	Lens Color	Source Color
SL-T3528IRURPC010-L180	Water Clear	Infrared/Red/Purple

Notes:

1. All dimensions are in millimeters.
2. Tolerance is ± 0.10 mm unless otherwise noted.
3. Specifications are subject to change without notice.

Electrical Optical Characteristics at Ta=25°C

Parameter	Symbol	Color	Min.	Typ.	Max.	Unit	Test Condition
Radiant Intensity	I _e	Infrared	1.0	2.0	---	mW/sr	I _F =10mA
Luminous Intensity	I _v	Red	200	330	---	mcd	I _F =10mA
		Purple	10	22	---	mcd	I _F =10mA
Viewing Angle	2 _{1/2}	---	---	120	---	Deg.	(Note 2)
Peak Emission Wavelength	p	Infrared	---	850	---	nm	I _F =10mA
		Red	---	635	---	nm	I _F =10mA

Typical Electrical / Optical Characteristics Curves for Red (25°C Ambient Temperature Unless Otherwise Noted)

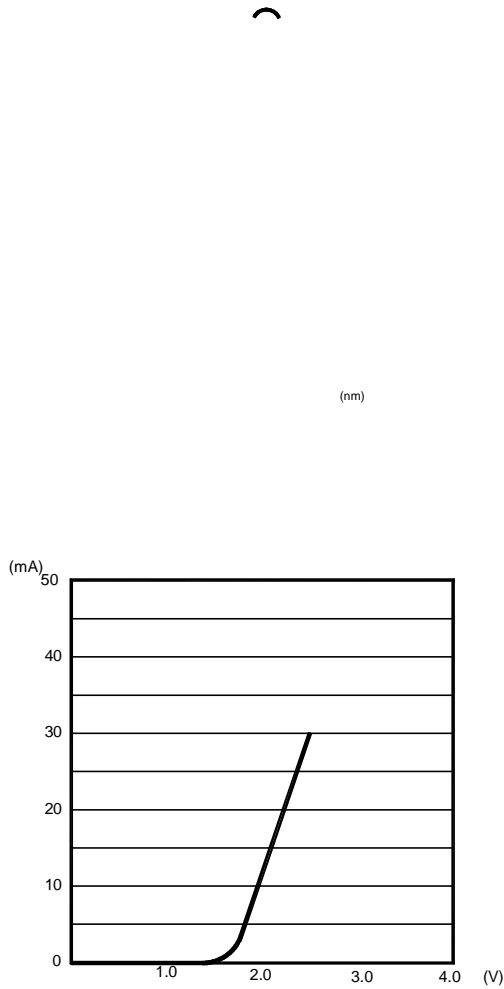

(nm)

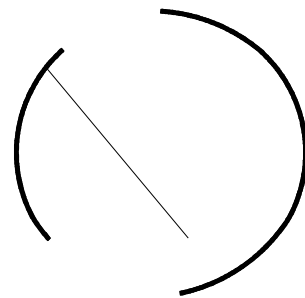
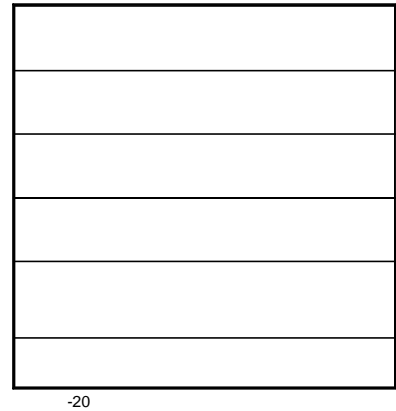

Label Explanation

LIGHT Universal Label

LIGHT		RoHS
Light Electronics CO., LTD.		
MODEL NAME: _____	 LOT NO. : _____	
QUANTITY: _____		
BIN: _____		
PACKING DATE: _____		
REMARKS: _____		

Customer Defined Label

LIGHT		RoHS
Light Electronics CO., LTD.		
MODEL NAME: _____	 LOT NO. : _____	
QUANTITY: _____		
BIN: _____		
PACKING DATE: _____		
CUSTOMER P/N: _____		

Reel Dimensions

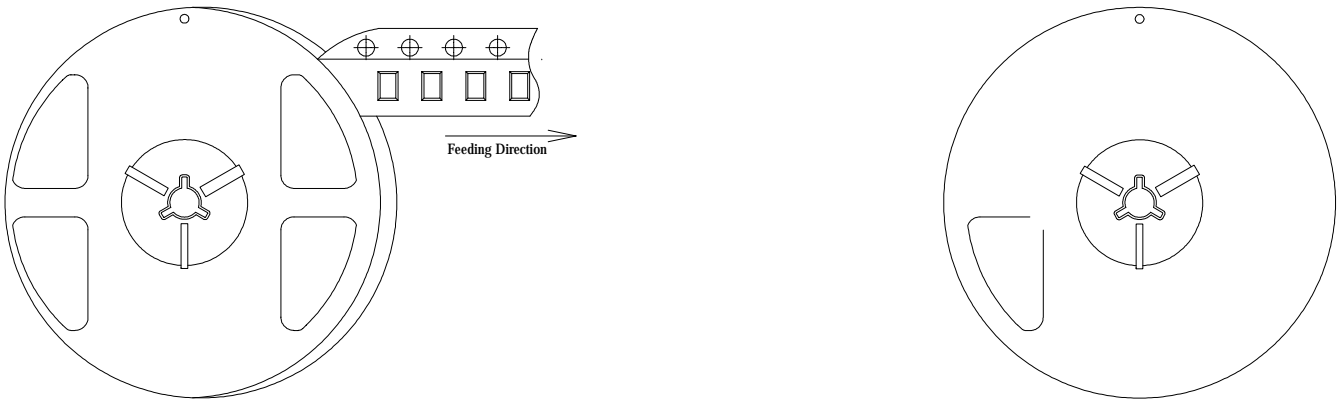

Note: Tolerance unless mentioned is $\pm 0.2\text{mm}$; Unit = mm

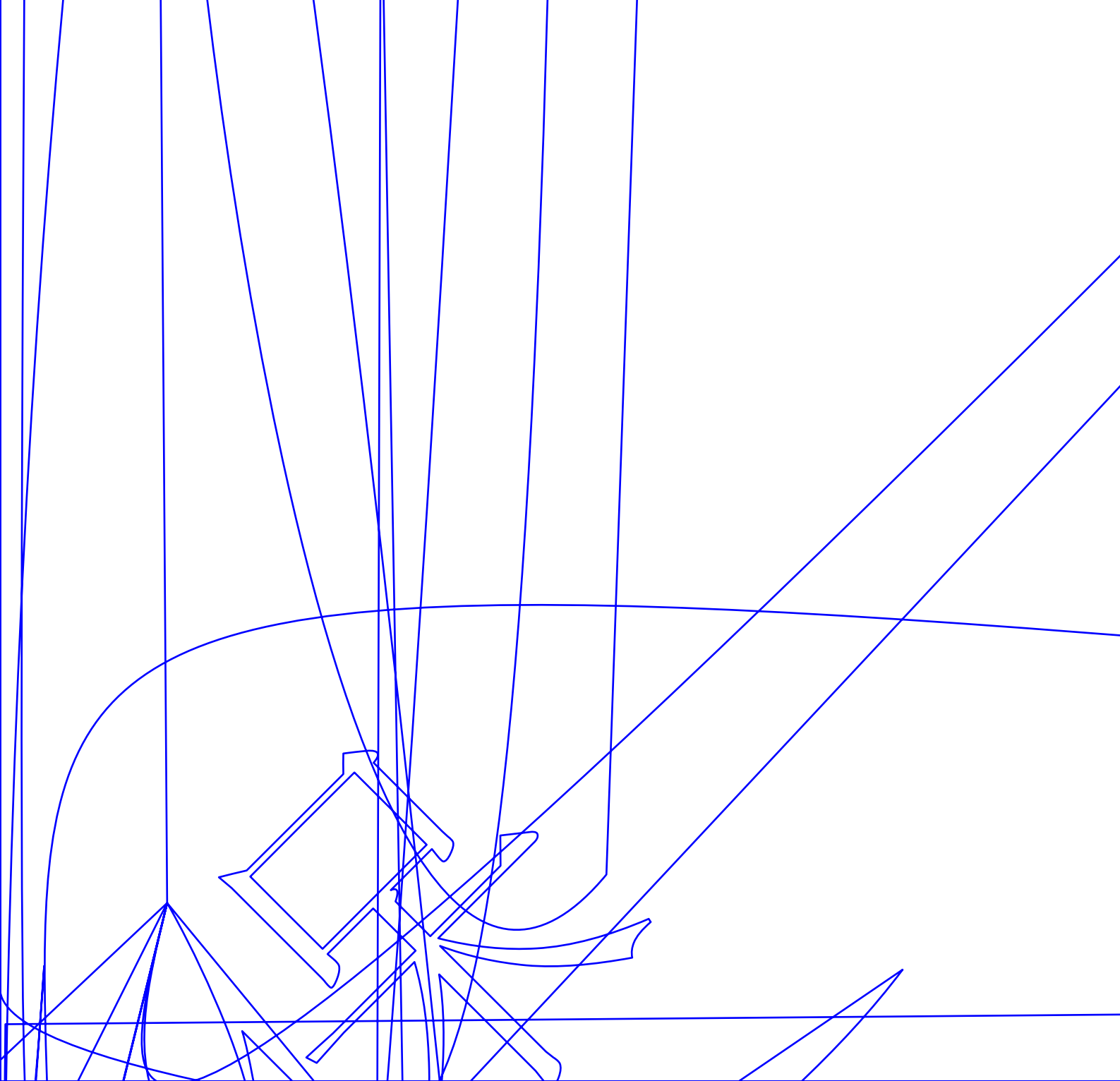

Reflow Soldering

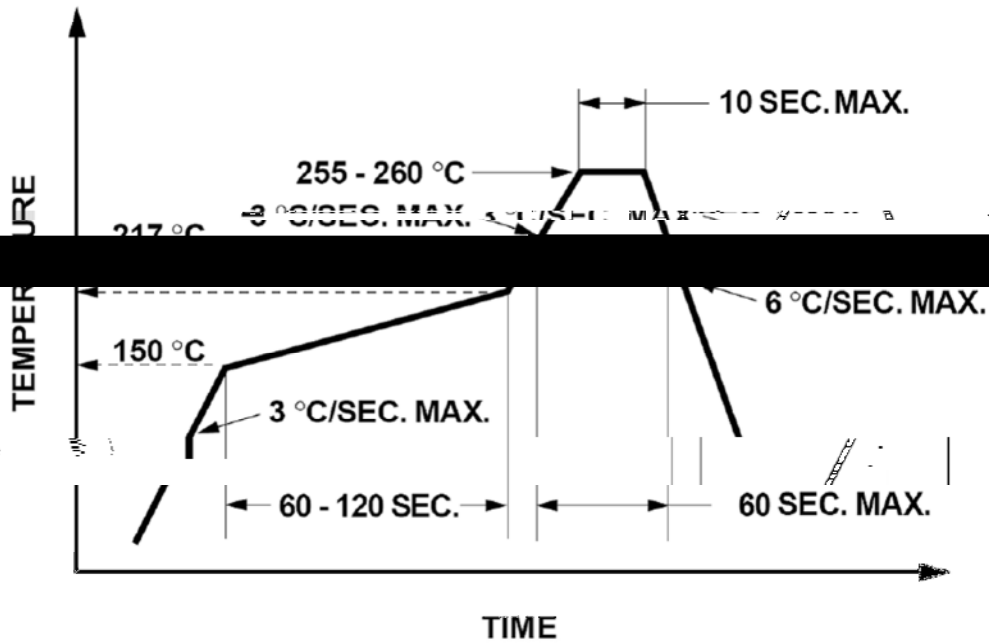

1. Reflow soldering should not be done more than two times.
2. When soldering, do not put stress on the LEDs during heating.

Soldering iron

1. When hand soldering, the temperature of the iron must less than 300°C for 3 seconds.
2. The hand solder should be done only once.

Repairing

Repair should not be done after the LEDs have been soldered. When repairing is unavoidable, a double-head soldering iron should be used (as below figure). It should be confirmed beforehand whether the characteristics of LEDs will or will not be damaged by repairing.

