

SL-T3528IR-850-1.4-R

DATA SHEET

SPEC. NO. : SZ20030501
DATE : 2020/03/05
REV. : A/1

Approved By:

Checked By:

Prepared By:

Features

- Pb free product—RoHS compliant
- Low power consumption, High efficiency
- Reliable and rugged
- Long life – solid state reliability
- Radiant angle: 120°

Package Dimension

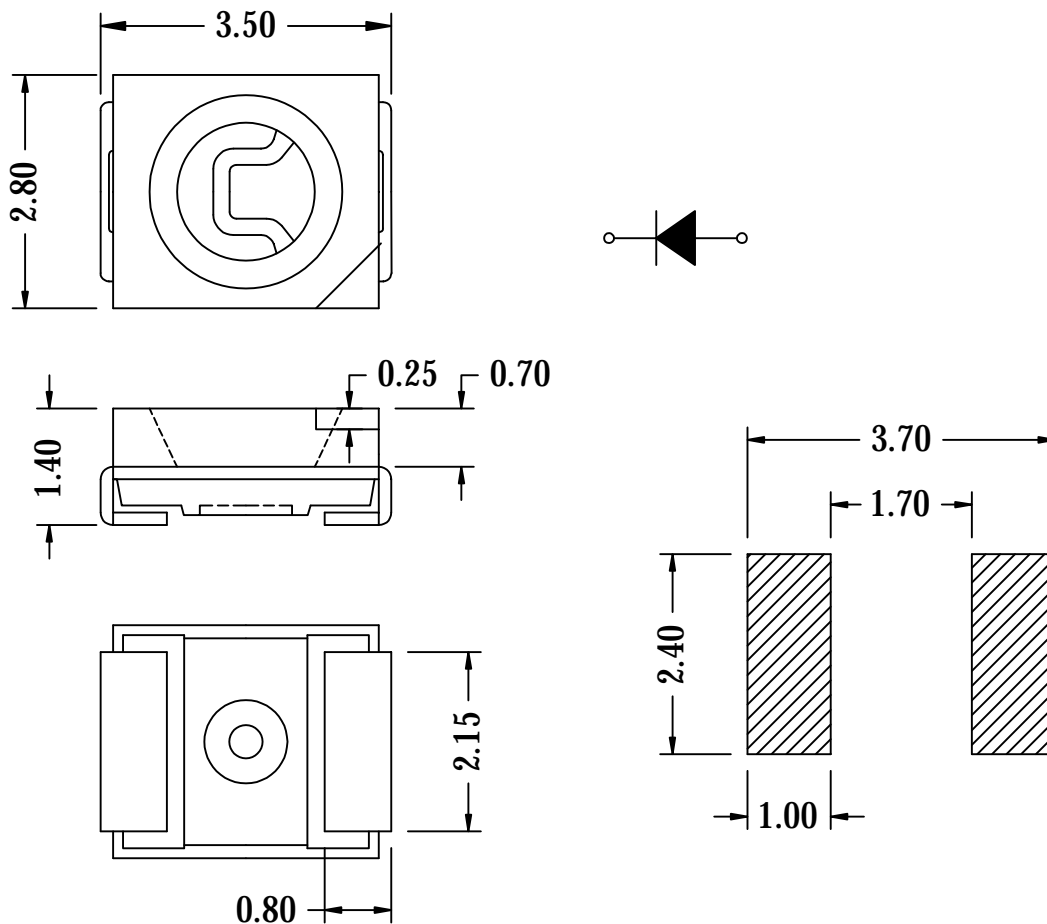

| Part NO. | Chip Material | Lens Color |
|----------------------|---------------|-------------|
| SL-T3528IR-850-1.4-R | AlGaAs/Si | Water Clear |

Notes:

1. All dimensions are in millimeters.
2. Tolerance is ± 0.10 mm unless otherwise noted
3. Specifications are subject to change without notice.



Typical Electrical / Optical Characteristics Curves (25 Ambient Temperature Unless Otherwise Noted)

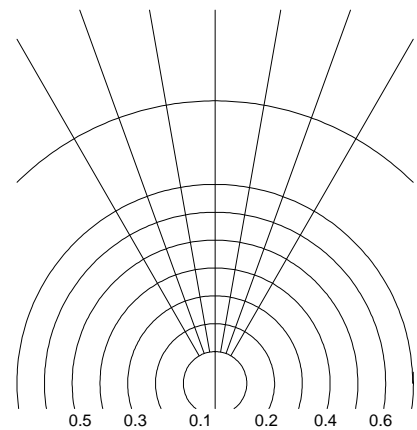
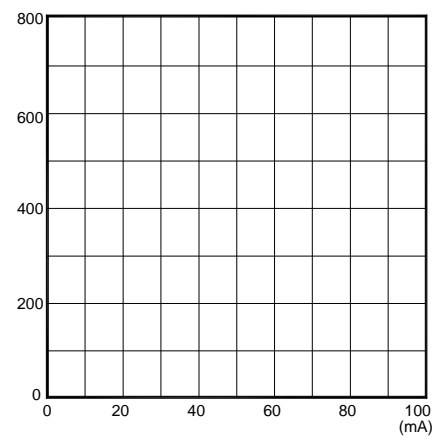
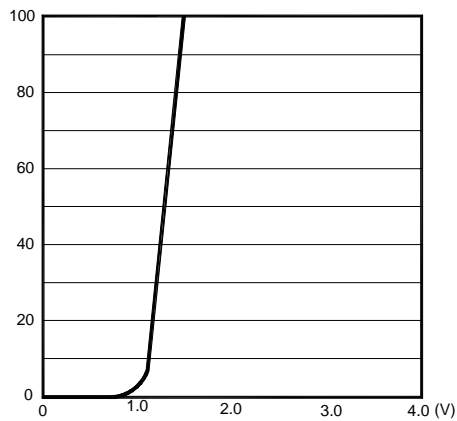
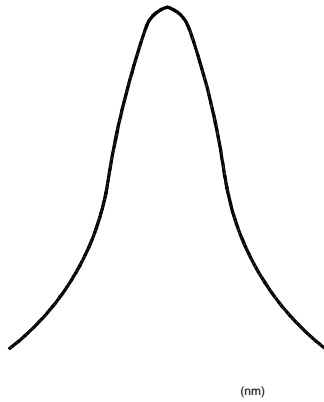

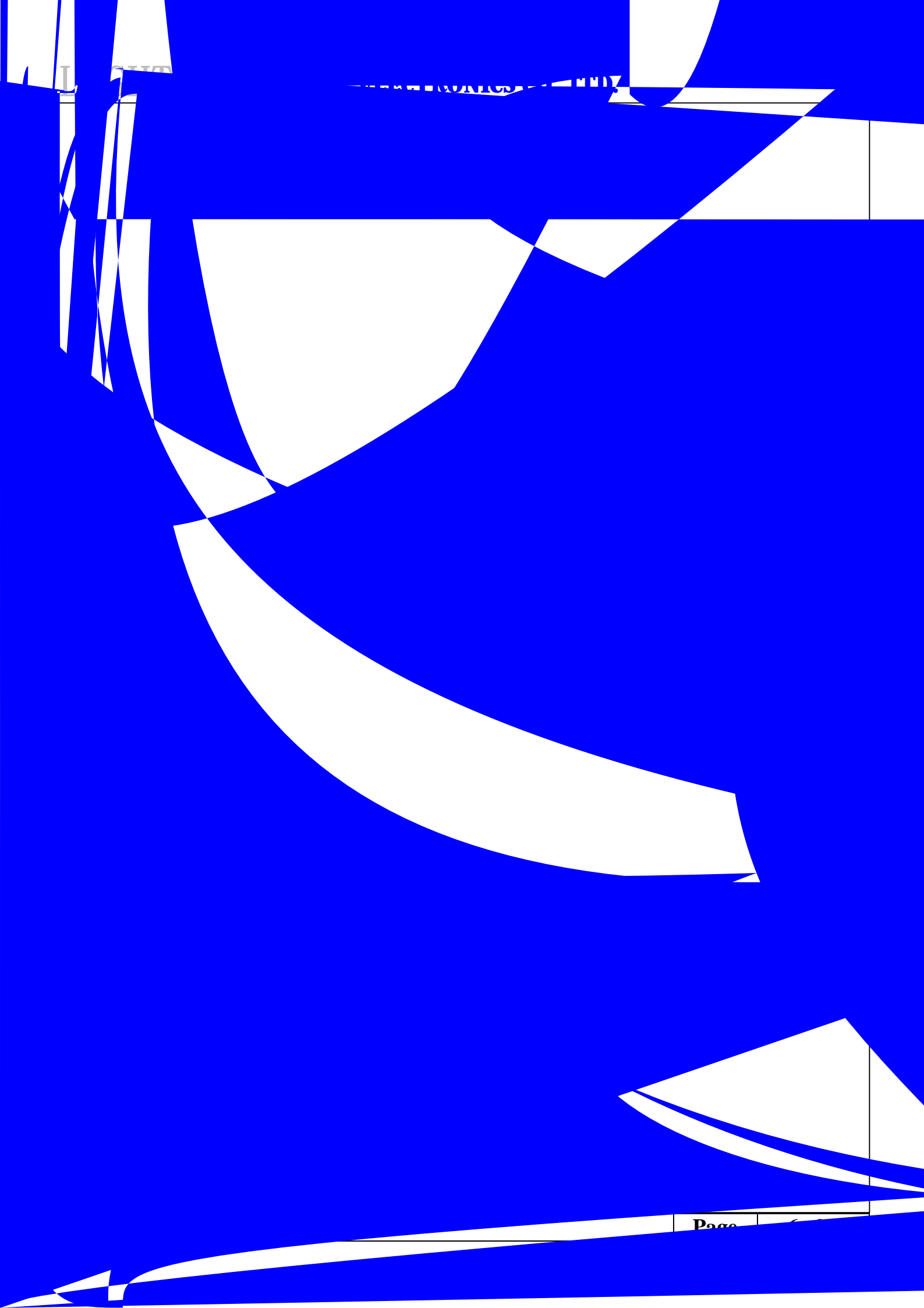

Label Explanation

| | |
|-----------------------------|--|
| LIGHT | |
| Light Electronics CO., LTD. | |
| MODEL NAME: _____ |  LOT NO. : _____ |
| QUANTITY: _____ | |
| BIN _____ | |
| PACKING DATE: _____ | |
| REMARKS: _____ | |

