

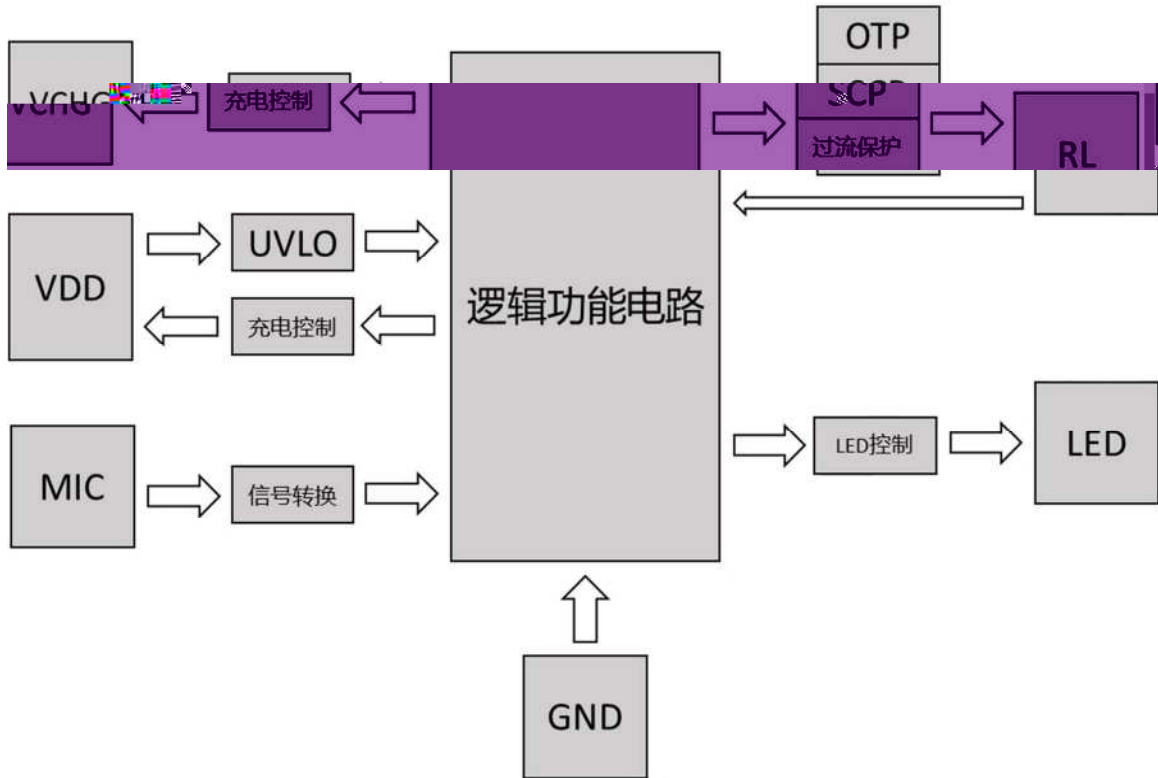



1.

2.

2.1

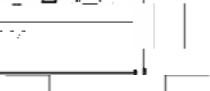

2.2

外形	序号	符号	功能描述
	1	VCHG	充电电源输入
	2	GND	地
	3	MIC	吸烟检测 (SENSOR)
	5	VOUT	接电热丝
	6	VDD	接电源正端

2.3

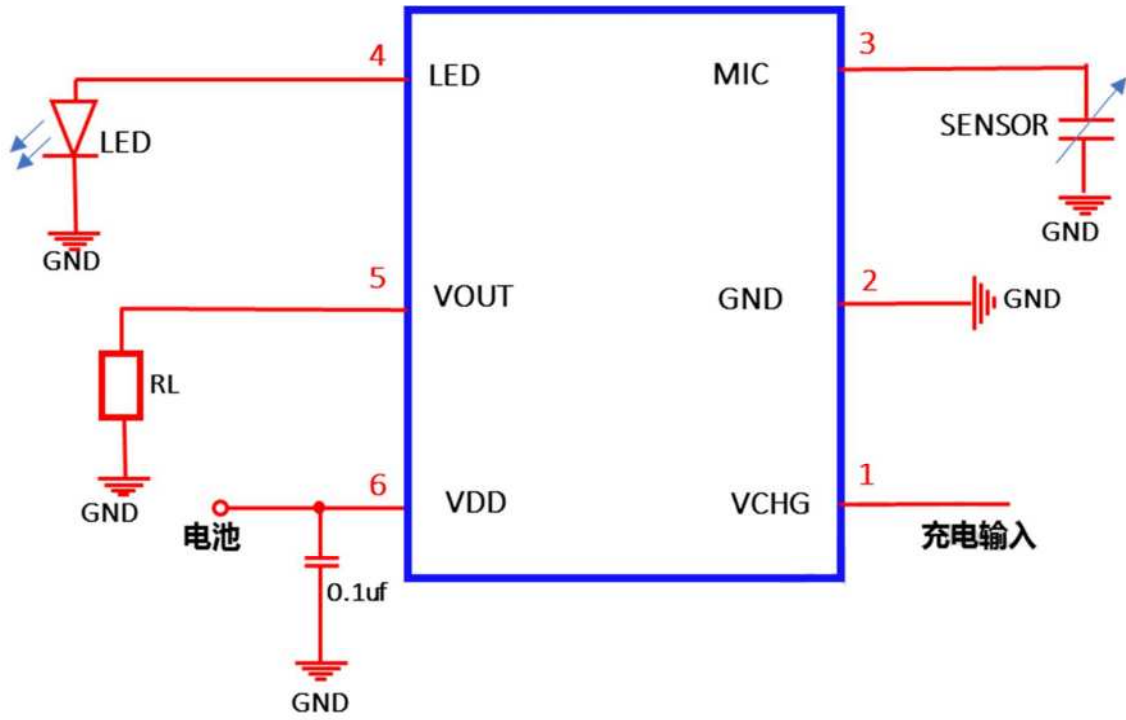

2.4

2.4.1

2.4.2 LED

2.4.3

2.4.4

OSC

2.4.5

2.5 LED

	LED



4.

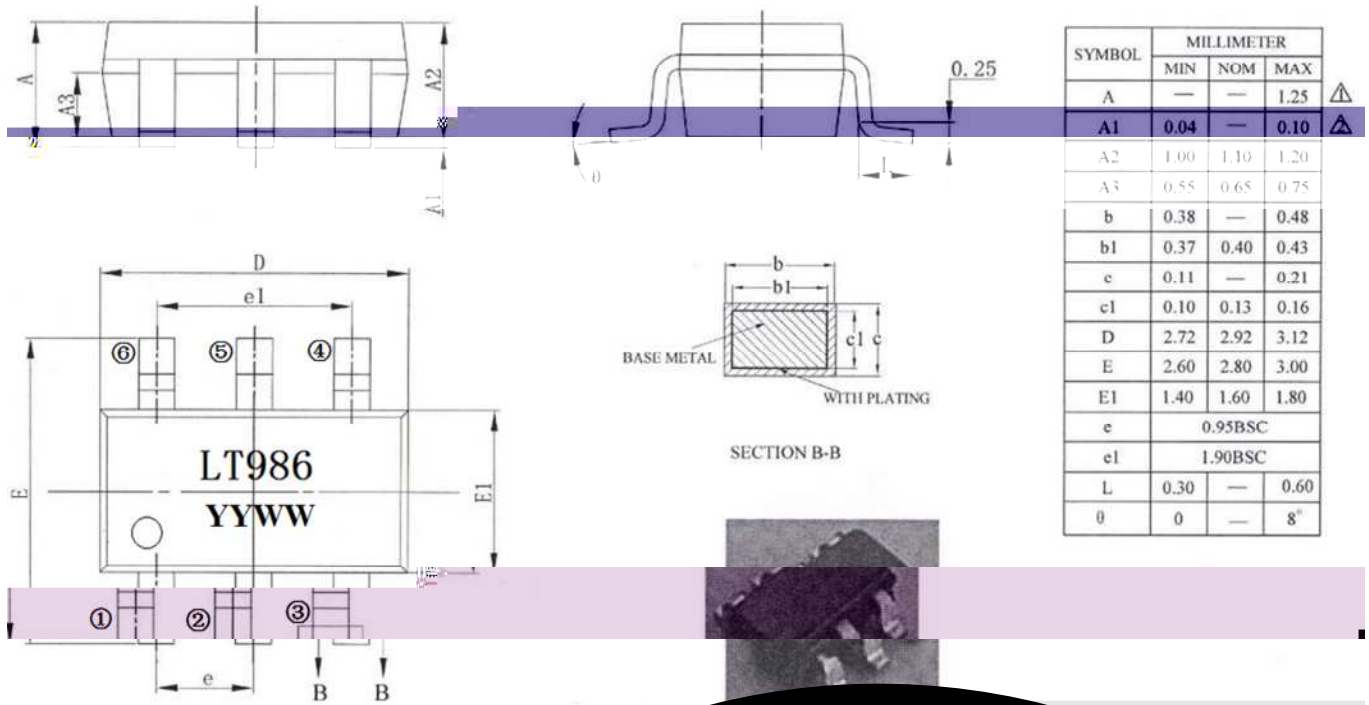

5.

5.1

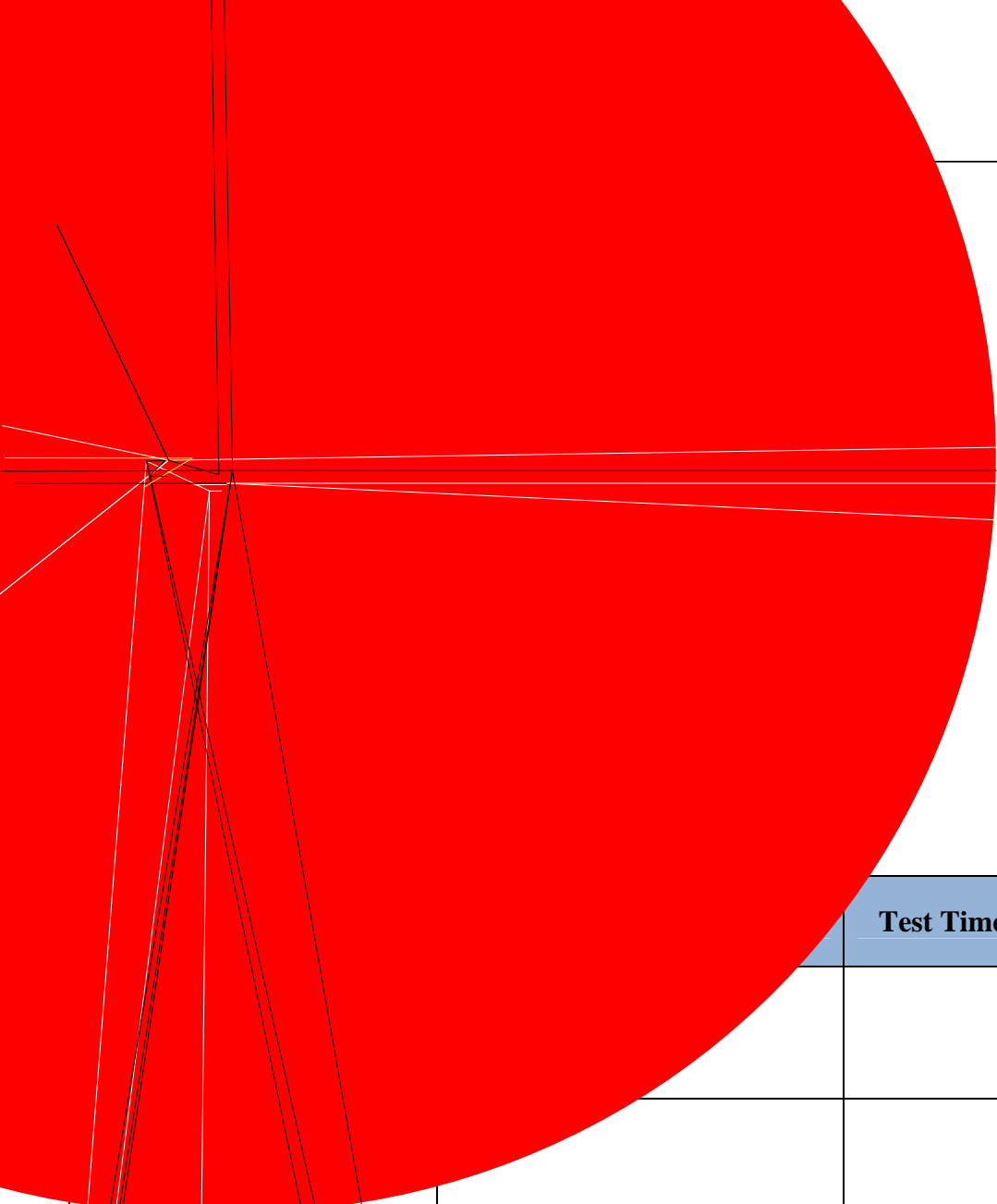

Test Time	Quantity	Ac/Re