

Part NO.	Chip Material	Lens Color
SL-T4232PDB020-L415	Silicon	Black

**Notes:**

1. All dimensions are in millimeters.
2. Tolerance is  $\pm 0.10\text{mm}$  unless otherwise noted.
3. Specifications are subject to change without notice.





## Typical Electrical / Optical Characteristics Curves (25 Ambient Temperature Unless Otherwise Noted)

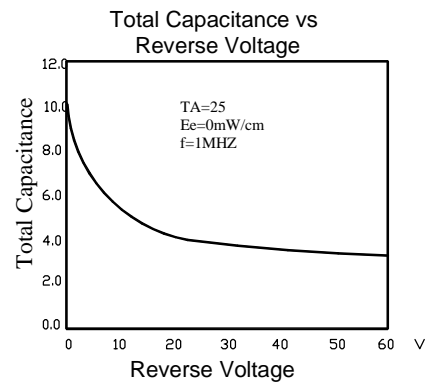
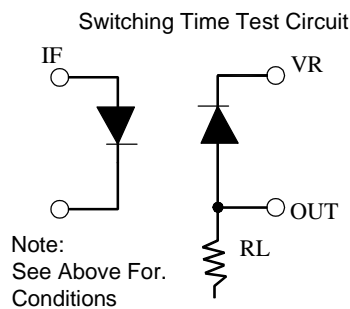
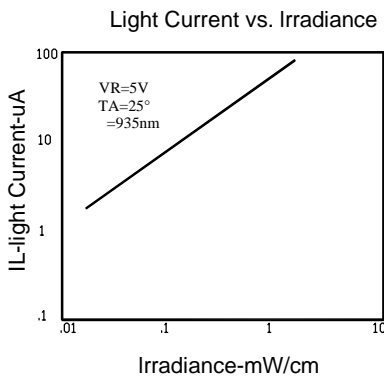
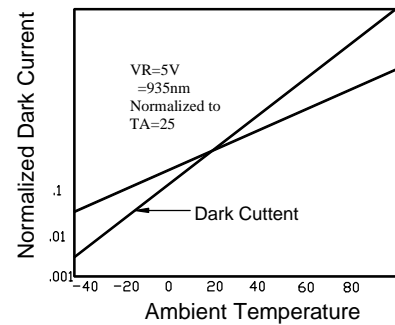
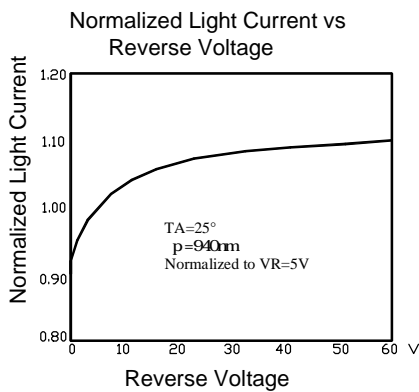
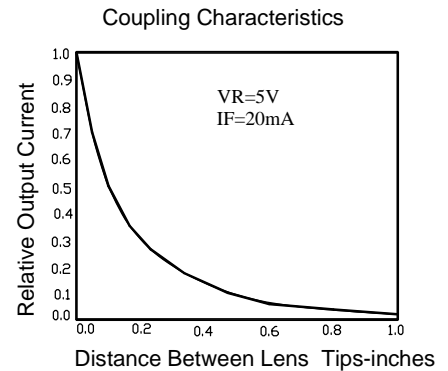
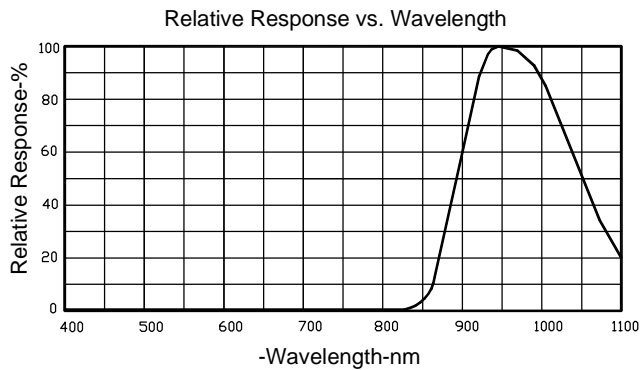



# LIGHT

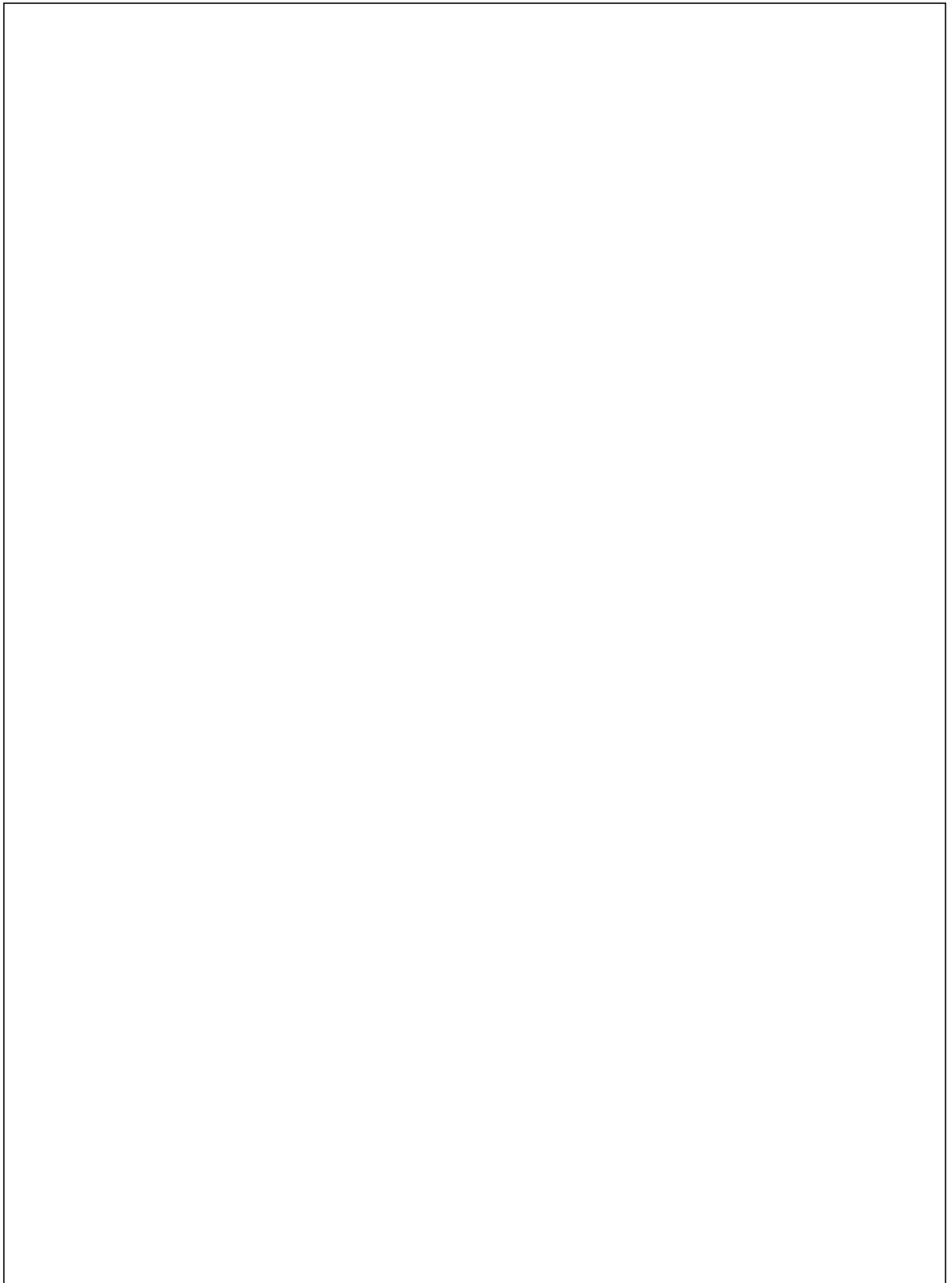

LIGHT

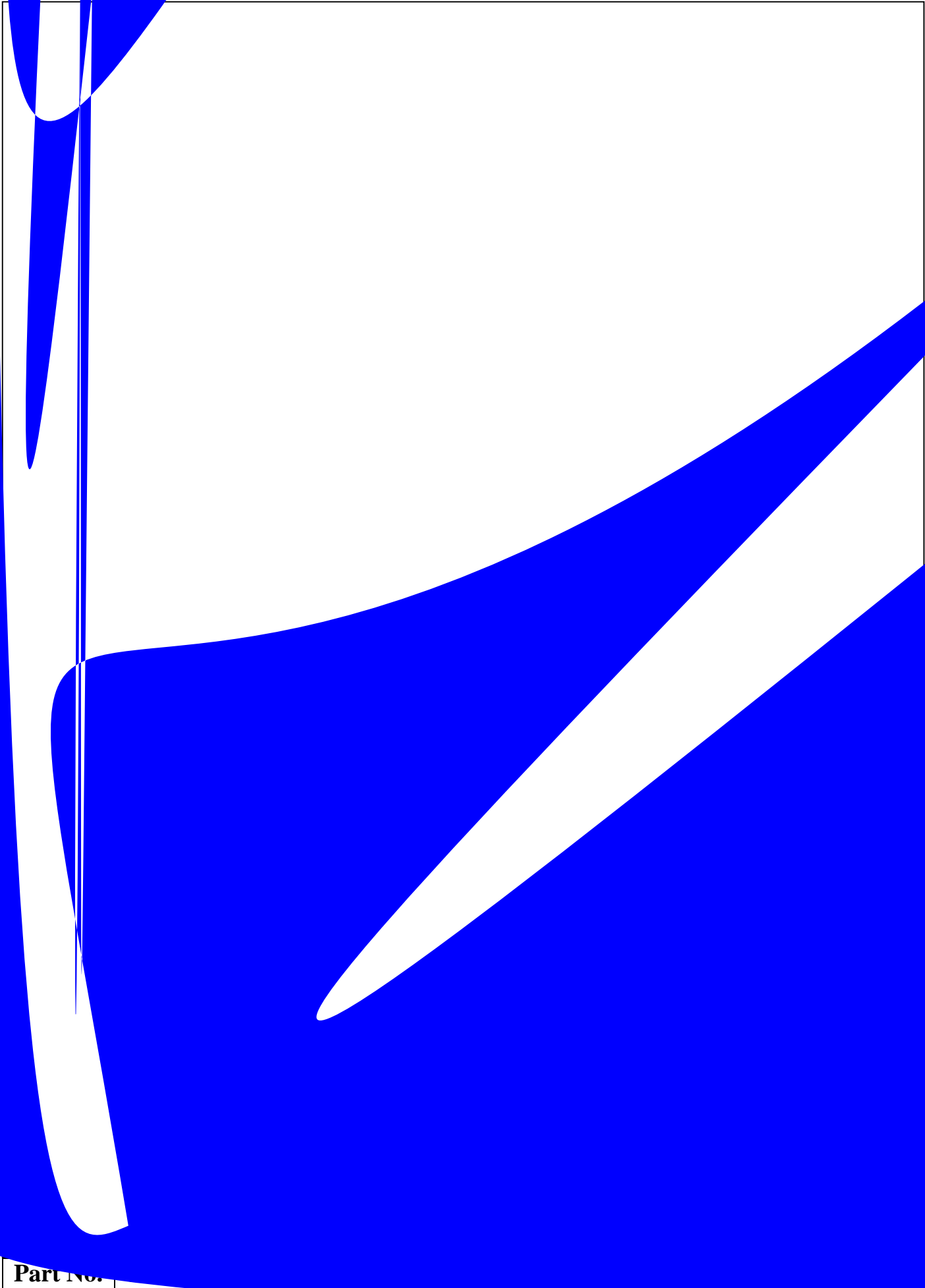

Part No.



