

REV

|

|

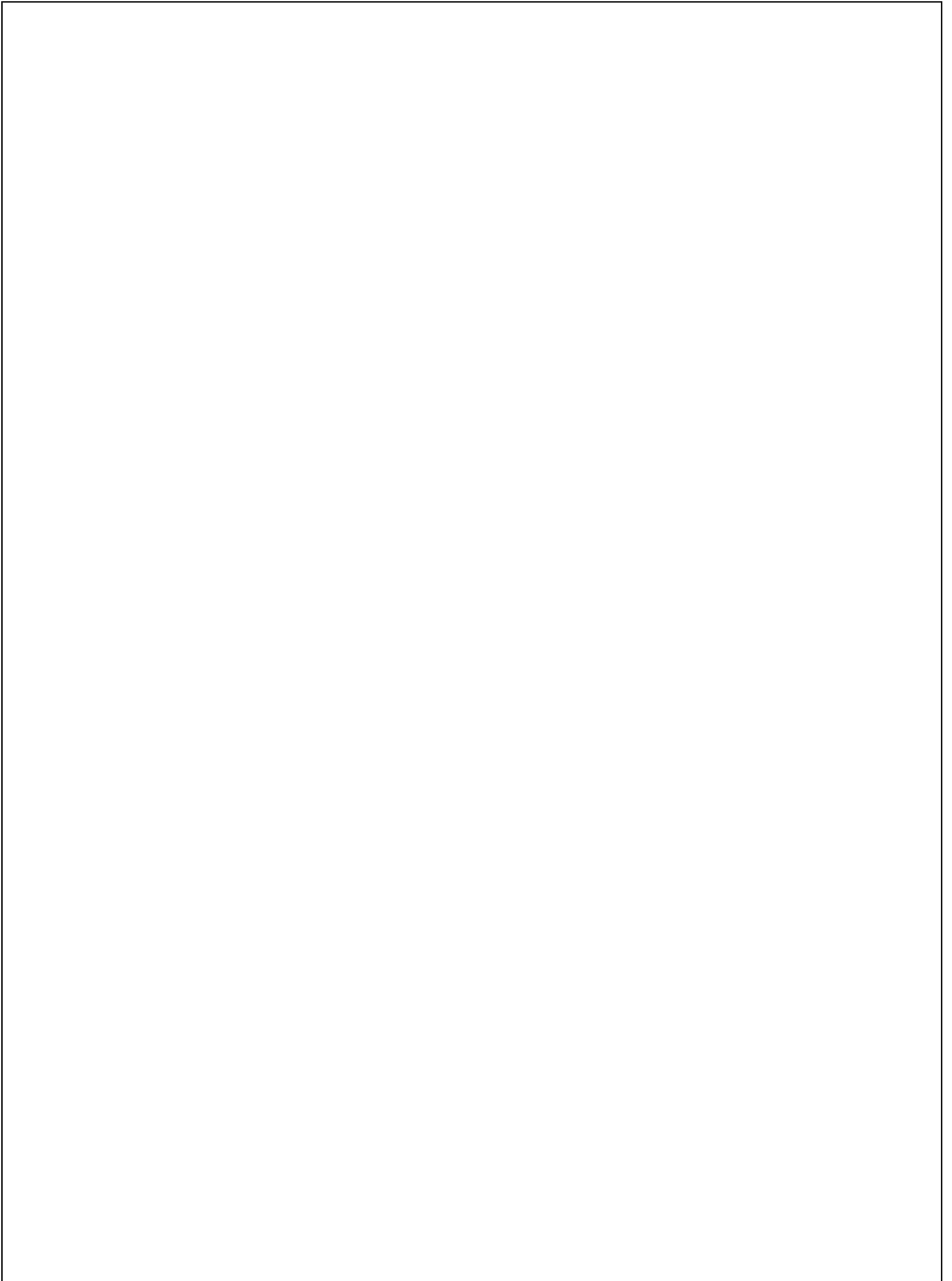



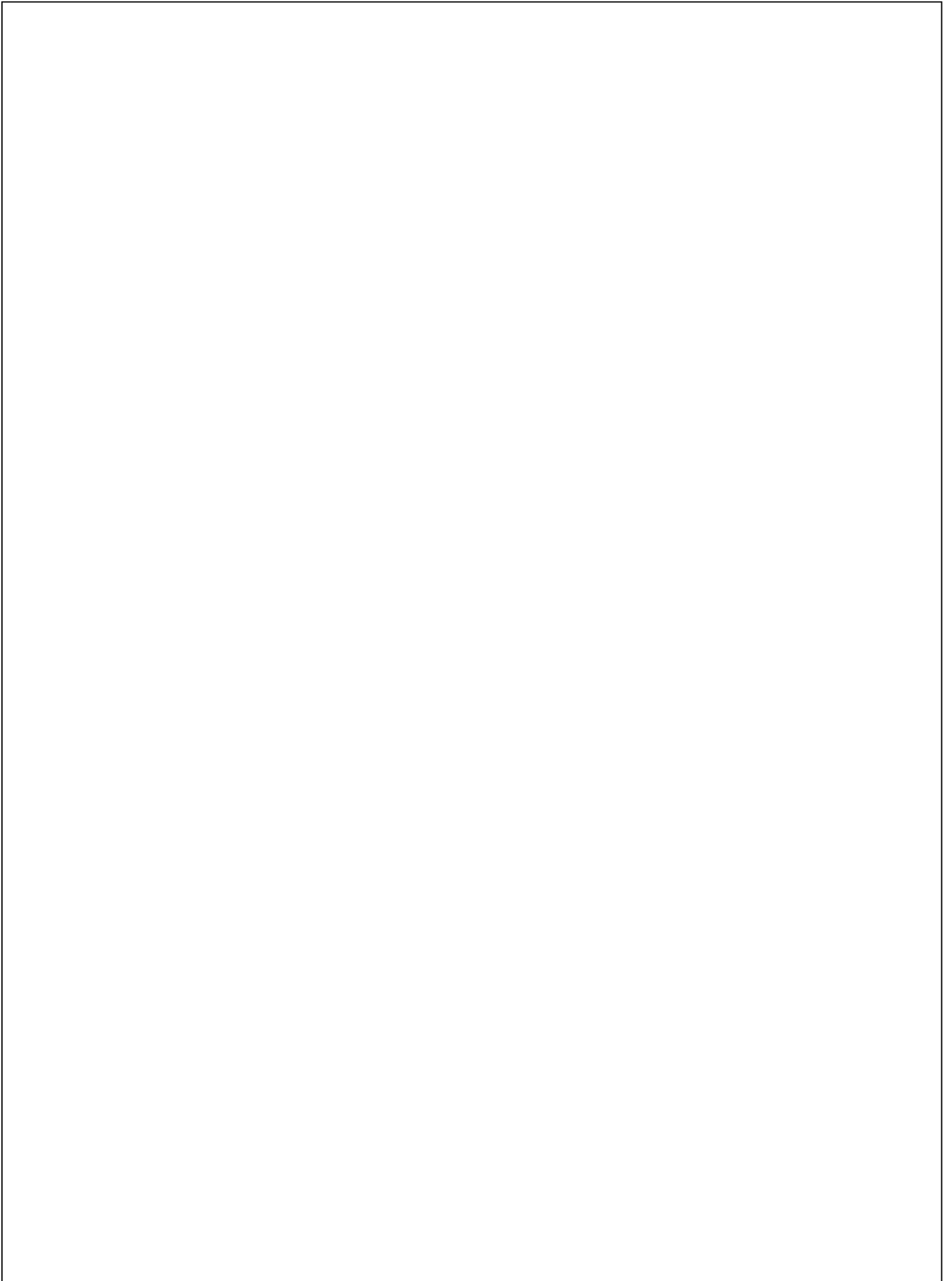

--	--	--	--

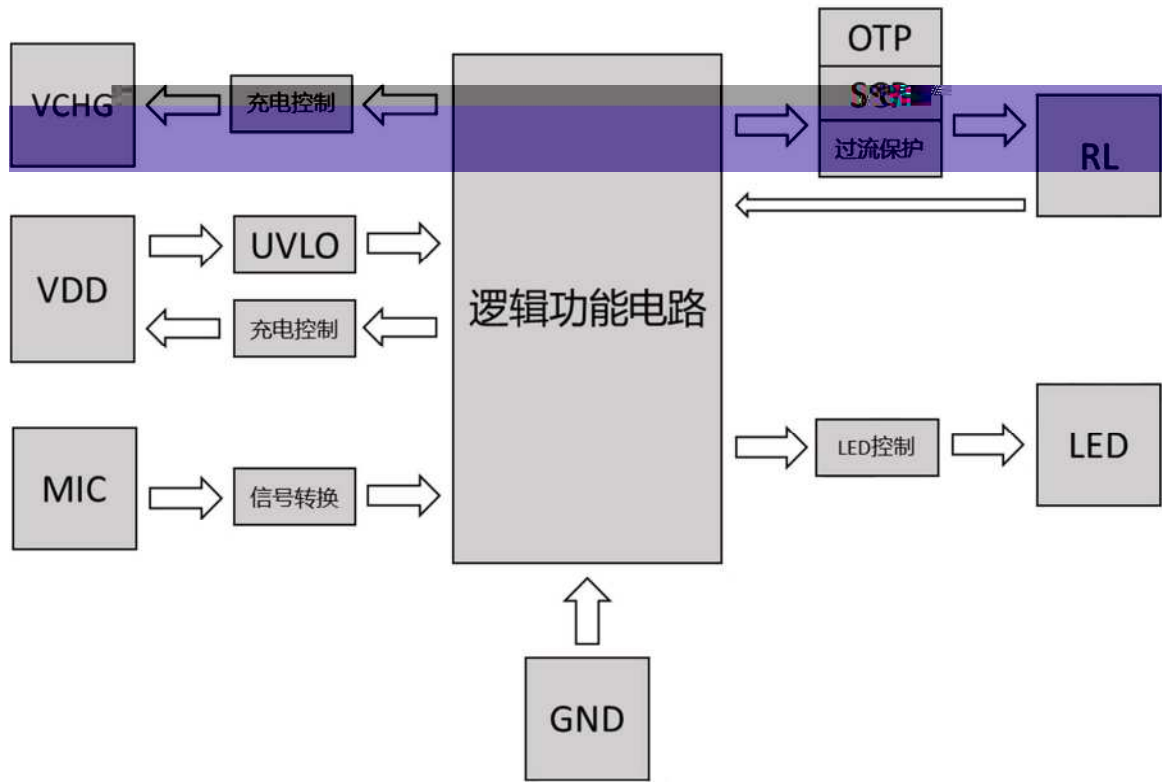

--	--	--	--



外形	序号	符号	功能描述
	1	VCHG	充电电源输入
	2	GND	地
	3	MIC	吸烟检测 (SENSOR)
	5	VOUT	接电热丝
	6	VDD	电池正端

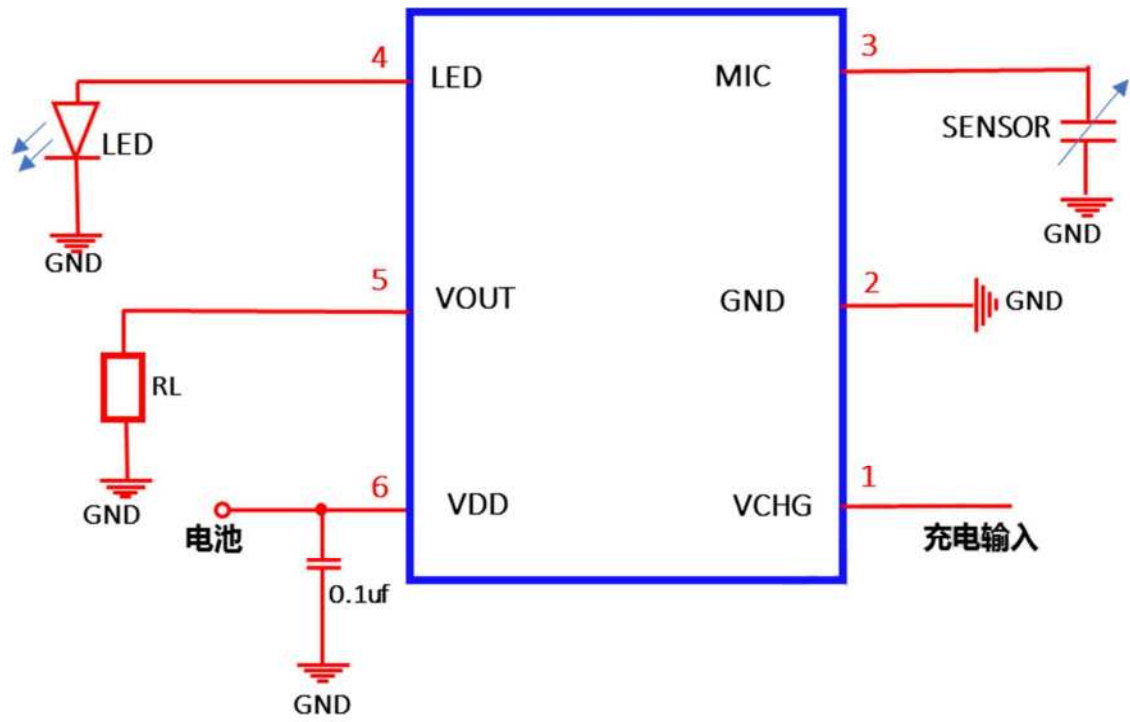

--	--	--	--





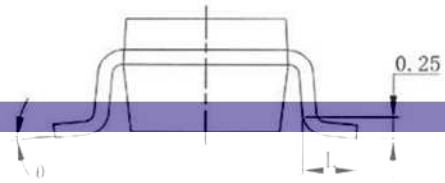
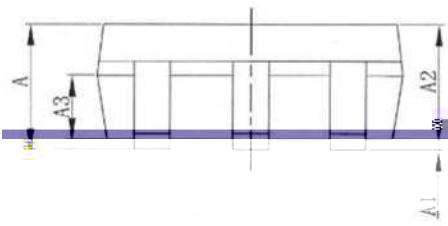

SYMBOL	MILLIMETER		
	MIN	NOM	MAX
A	—	—	1.25
A1	0.04	—	0.10
A2	1.00	1.10	1.20
A3	0.55	0.65	0.75
b	0.38	—	0.48
b1	0.37	0.40	0.43
e	0.11	—	0.21
e1	0.10	0.13	0.16
D	2.72	2.92	3.12
E	2.60	2.80	3.00
E1	1.40	1.60	1.80
e	0.95BSC		
e1	1.90BSC		
L	0.30	—	0.60
θ	0	—	8°

