

**LIGHT ELECTRONICS CO., LTD.**

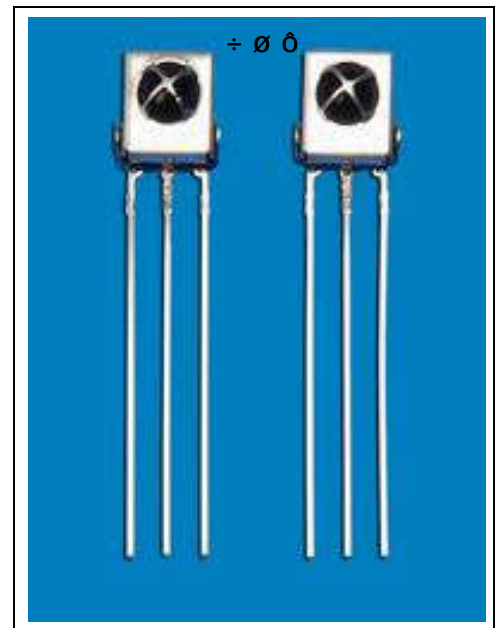

<b>Part No.</b>	<b>LG-IRM2A438KSF3</b>		
-----------------	------------------------	--	--

1 IRM2A438 SF3 PIN  
IC  
REACH ROHS



2 2.7-5.5V

3 TTL CMOS

MP3 MP4, 5, 6, 7, 8, 9, 10, 11, 12, 13, 14, 15, 16, 17, 18, 19, 20, 21, 22, 23, 24, 25, 26, 27, 28, 29, 30, 31, 32, 33, 34, 35, 36, 37, 38, 39, 40, 41, 42, 43, 44, 45, 46, 47, 48, 49, 50, 51, 52, 53, 54, 55, 56, 57, 58, 59, 60, 61, 62, 63, 64, 65, 66, 67, 68, 69, 70, 71, 72, 73, 74, 75, 76, 77, 78, 79, 80, 81, 82, 83, 84, 85, 86, 87, 88, 89, 90, 91, 92, 93, 94, 95, 96, 97, 98, 99, 100

4 0.0:

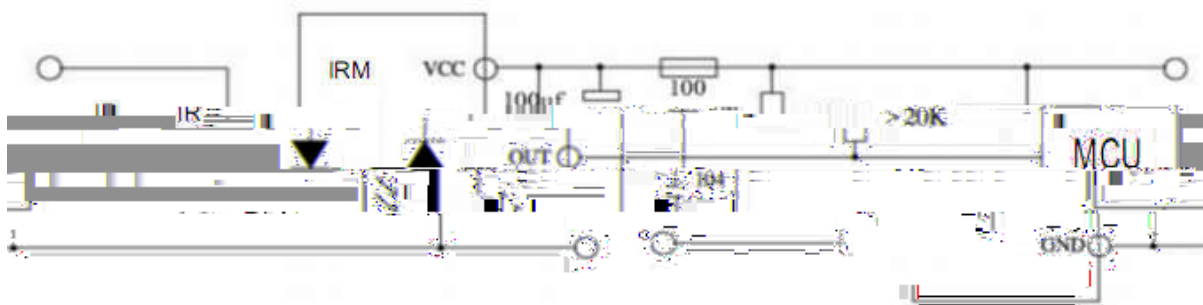

5 0.0:

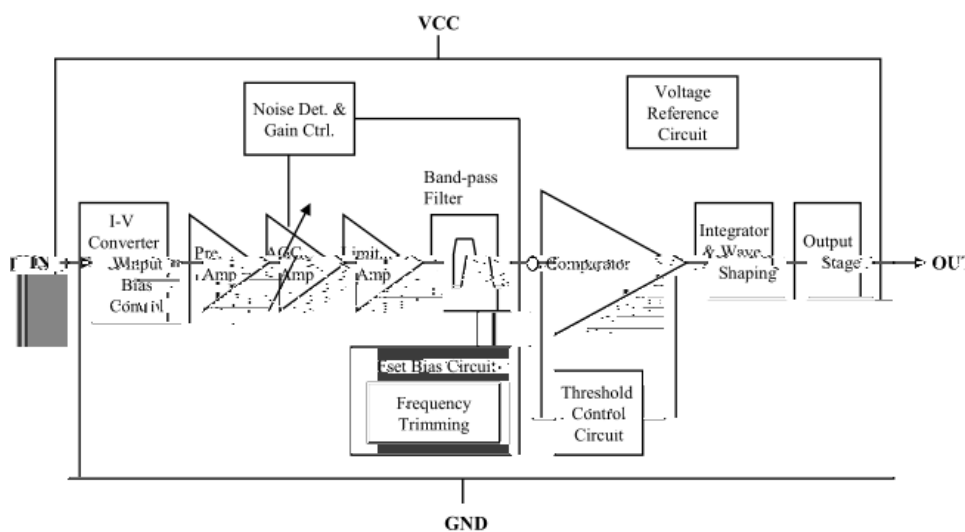

**LIGHT ELECTRONICS CO., LTD.**

L

**LIGHT ELECTRONICS CO., LTD.**

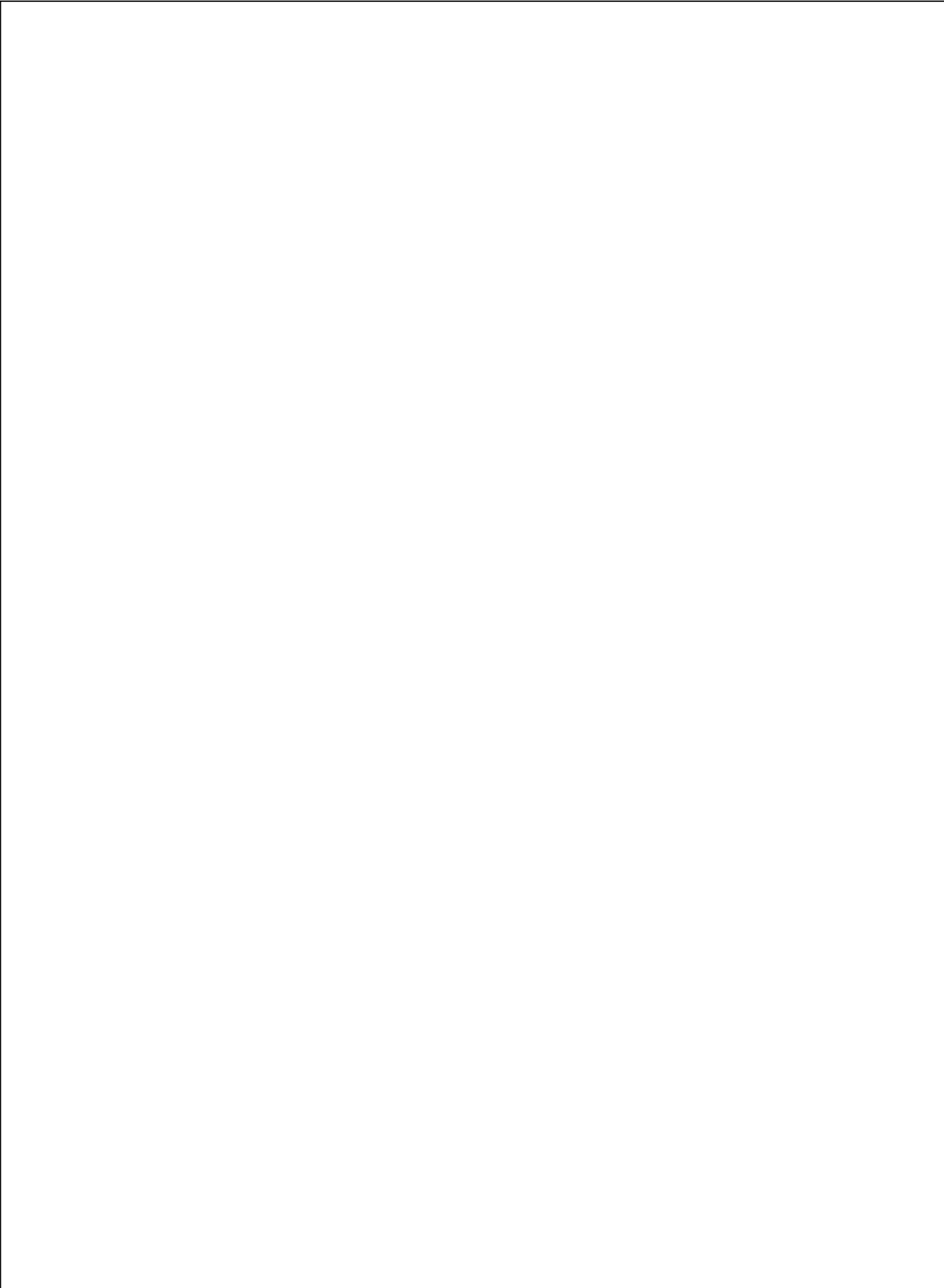

1ã

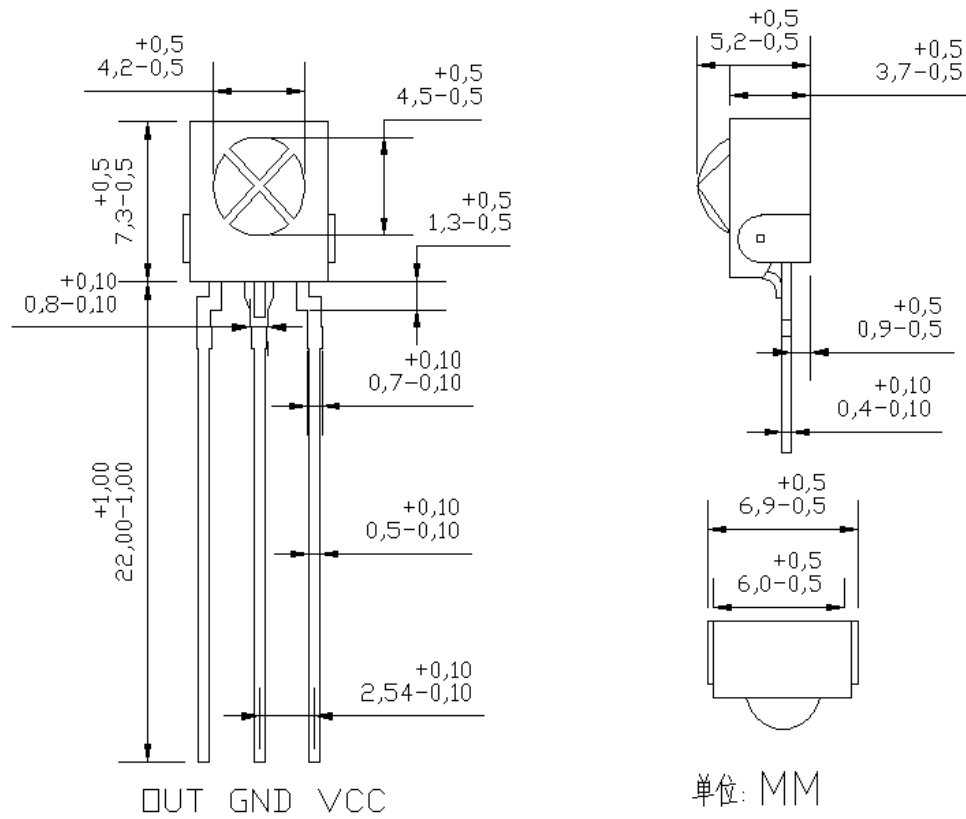

15

1è.

: 26pü 5 , ,  
 2  
 3

16.

1è.      è      ô ï

150mm× 190mm

ú      5pPCS

2è.

ô

ú      5pPCS

1p

ã

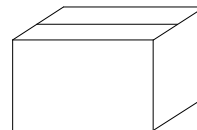
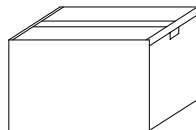
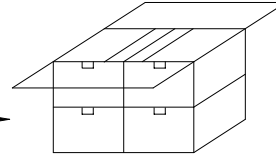
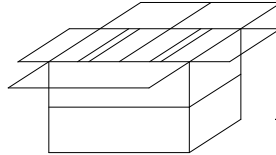
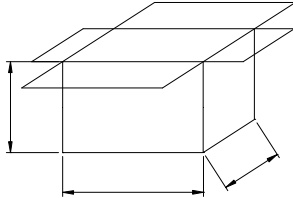
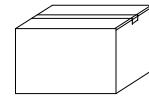
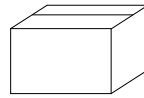
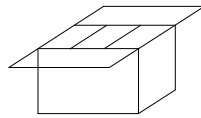
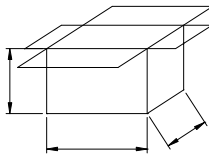
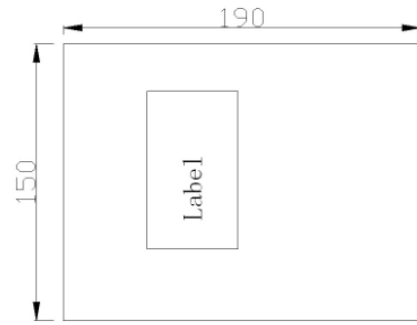

( pcs / )	( / )	( / )
<b>500</b>	<b>10</b>	<b>4</b>